

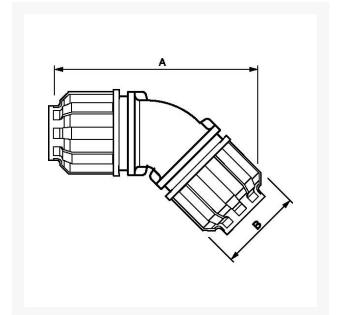

# Knje koppelng 20 mm 45 graden

## Product Images



## Additional Information

---

Artikelnummer	9ALR4C20
EAN	08712418282610
Gewicht (kg)	0.095000
Lengte (mm)	100
Breedte (mm)	47
Materiaal	Polyamide
Diameter Ø (mm)	20
Maximale druk (bar)	13 bij 40°C

